

www.khk.be

The logo of the K.U. Leuven Association is a circular emblem with the text 'ASSOCIATIE K.U. LEUVEN' written around the perimeter. The 'K.U.' is at the top, 'LEUVEN' is at the bottom, and 'ASSOCIATIE' is on the left side.

ASSOCIATIE K.U. LEUVEN

# Energiemonitoring: Technieken voor verlichting

- Bart Eestermans & Tom Van den Broeck
- <http://www.khk.be/remote>
- Katholieke Hogeschool Kempen  
Kenniscentrum Energiemanagement
- 05/06/2008

REMOTE

[www.khk.be](http://www.khk.be)



# Remote MOnitoring & control Techniques for Energy management

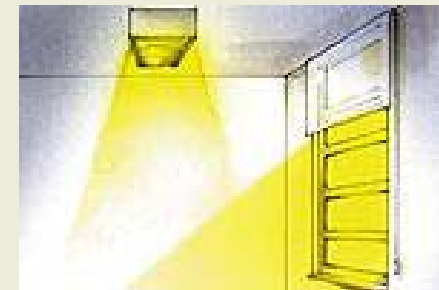
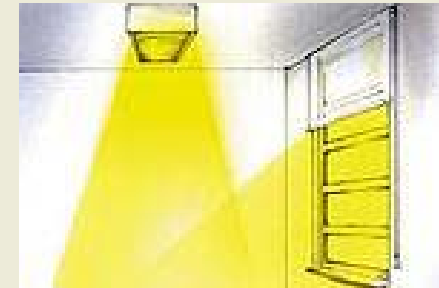

REMOTE

# Remote Monitoring & control Techniques for Energy management

- Monitoring en controle voor een energiezuinige verlichting
  - Lokaal (per armatuur)
  - Globaal (per kring/verdieping/gebouw)
- Communicatietechnologieën
- Data centralisatie en visualisatie

Partners:





# Agenda

1. **Inleiding**
2. Meten
3. Communicatie
4. Data Centralisatie en Visualisatie
5. Case Studies
6. Besluit

# Energie- en lichtmanagement

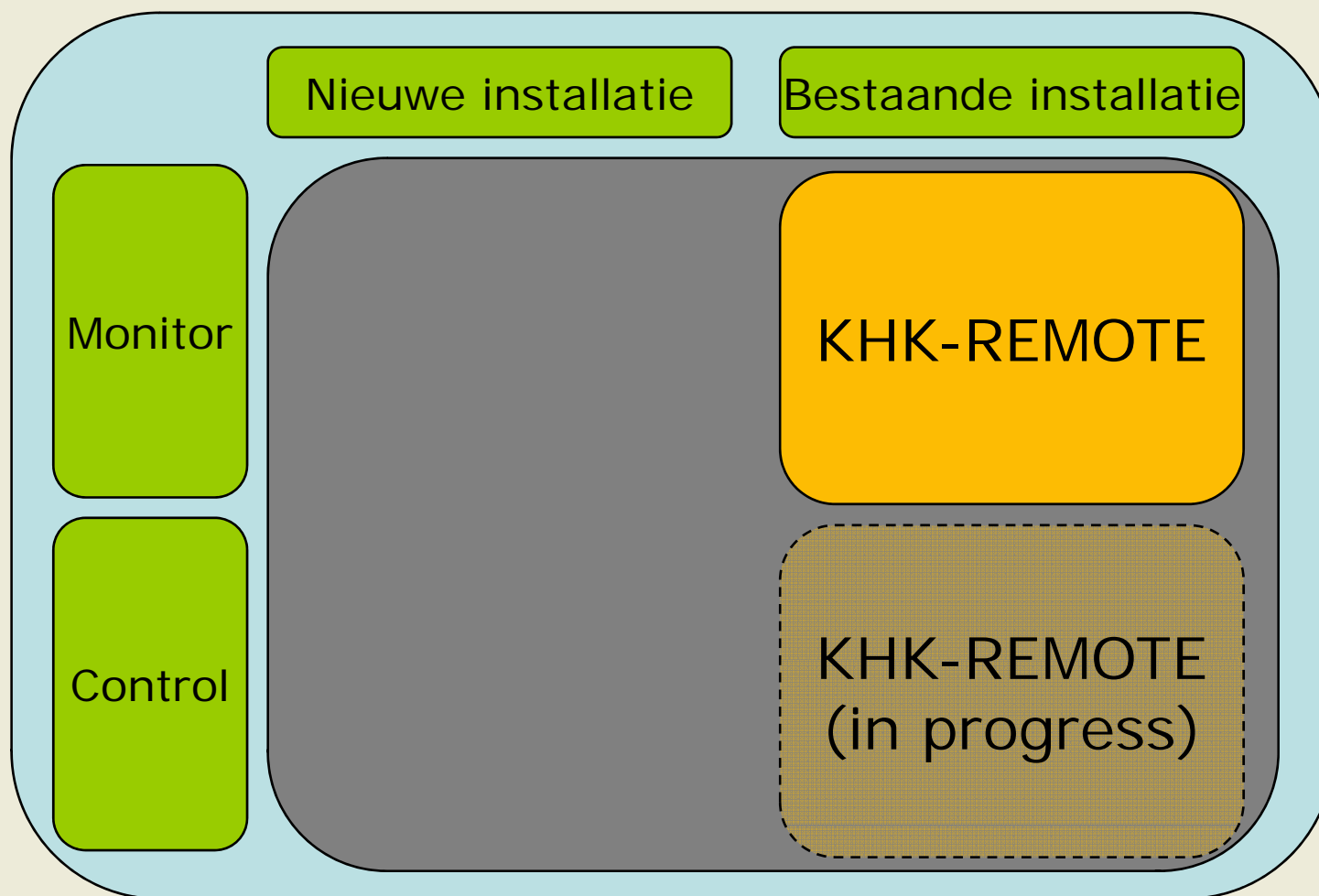

# Energiemonitoring: Technieken voor verlichting

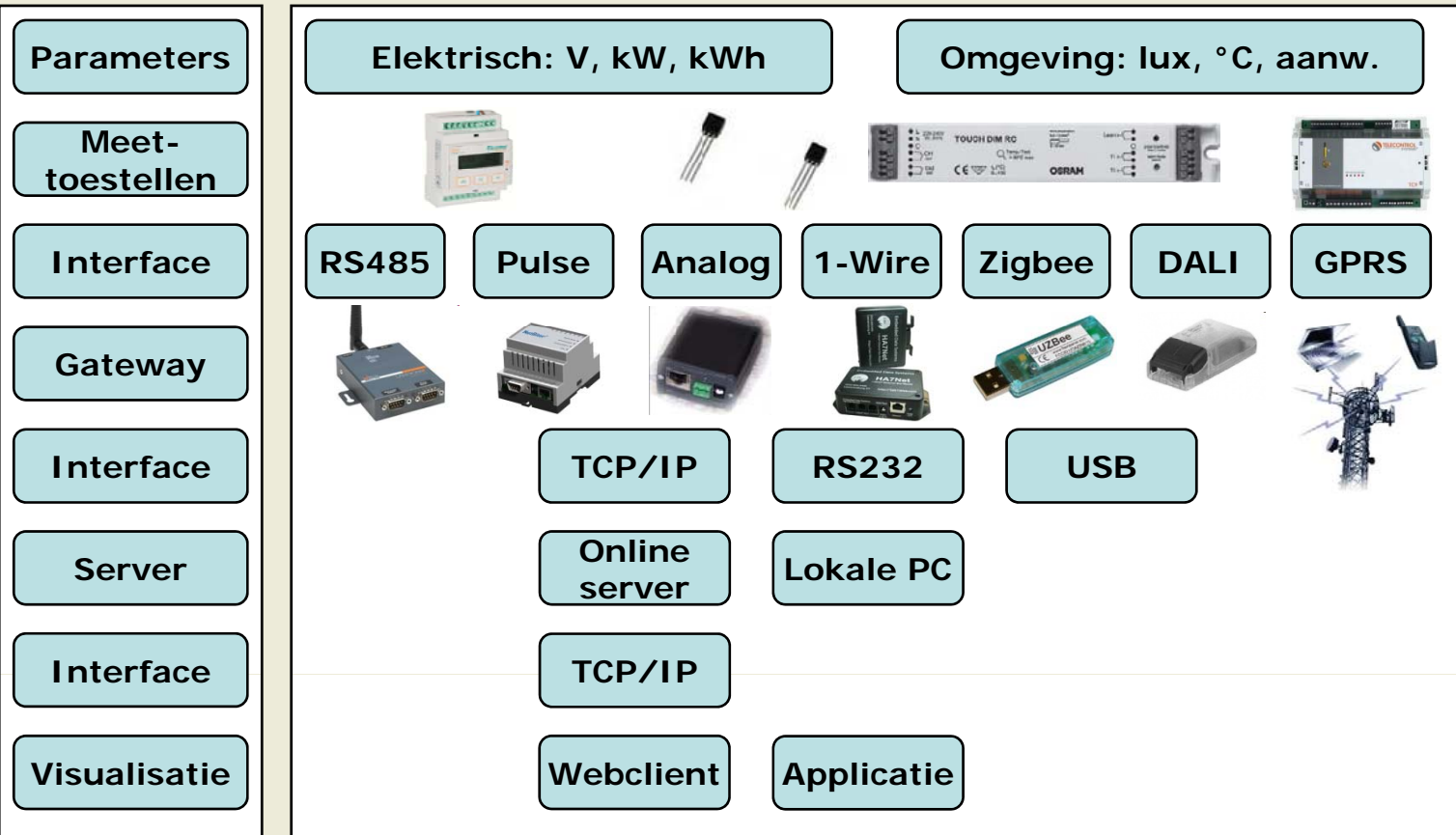



# Agenda

1. Inleiding
2. **Meten**
3. Communicatie
4. Data Centralisatie en Visualisatie
5. Case Studies
6. Besluit

# Energiemonitoring: Technieken voor verlichting

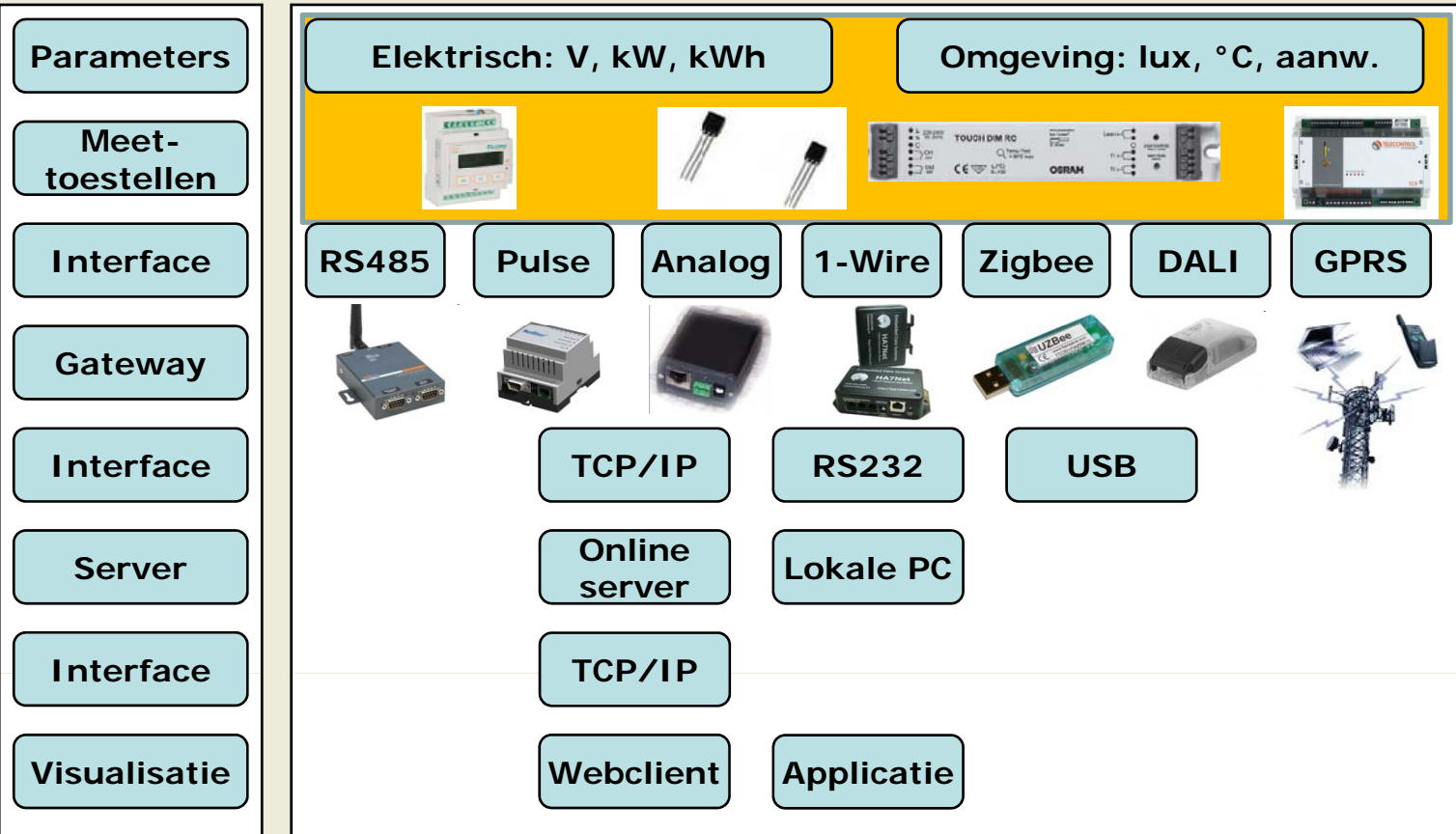



# Meten = duur?

- Per Site
- Per Gebouw
  - Puls contact - Indexis
- Per Ruimte
  - kW? – kWh? – h?
- Per Armatuur
  - Dimstand: Analoge <-> Digitale ballast
  - Gratis sturing?

# Meten = duur?

www.khk.be

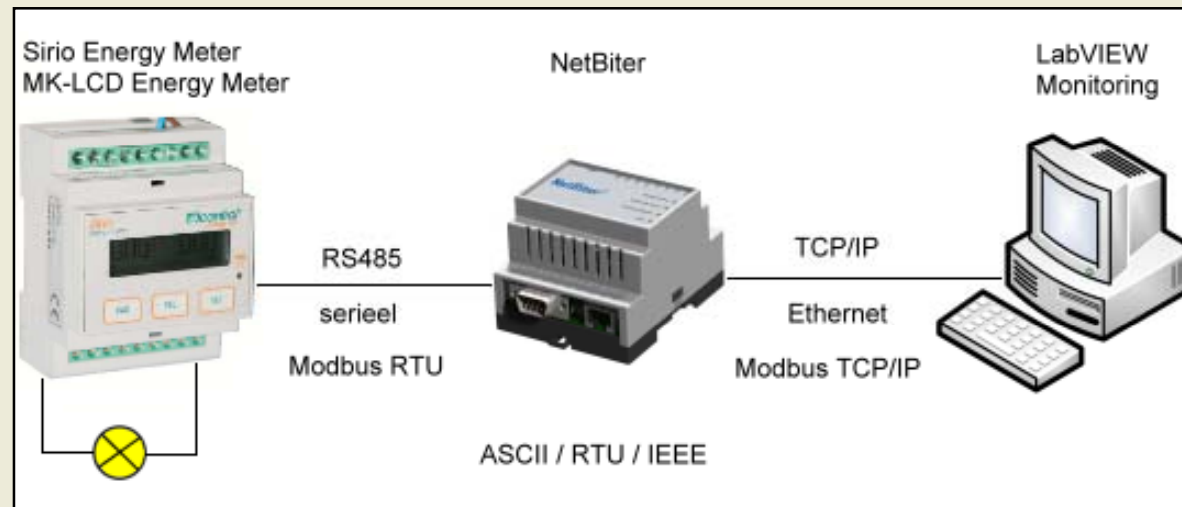

REMOTE



# Agenda

1. Inleiding
2. Meten
- 3. Communicatie**
4. Data Centralisatie en Visualisatie
5. Case Studies
6. Besluit

# Energiemonitoring: Technieken voor verlichting

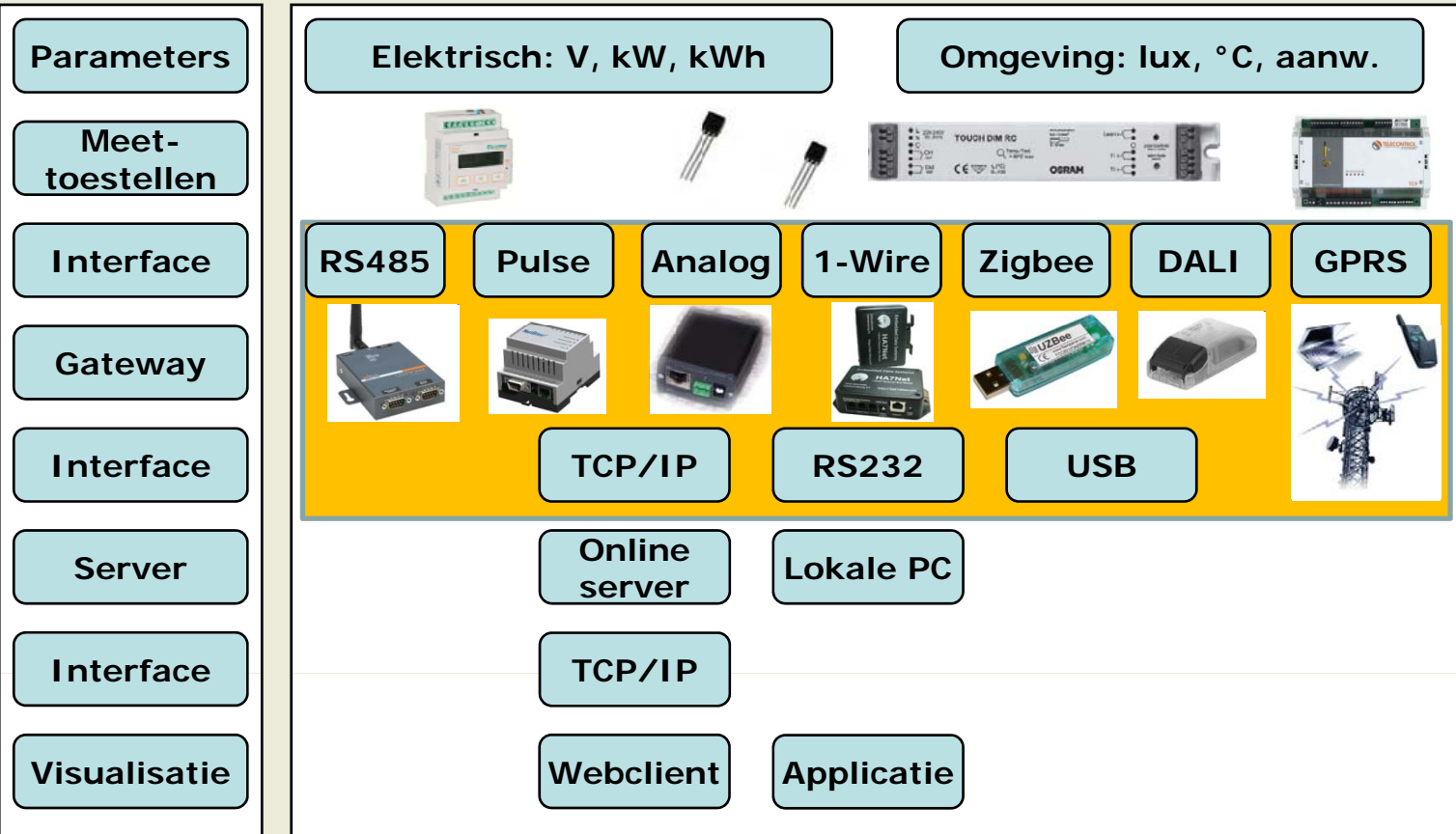

# Communicatie = extra kabels?

Ja, maar enkel tot:

- Gateway naar bestaand netwerk

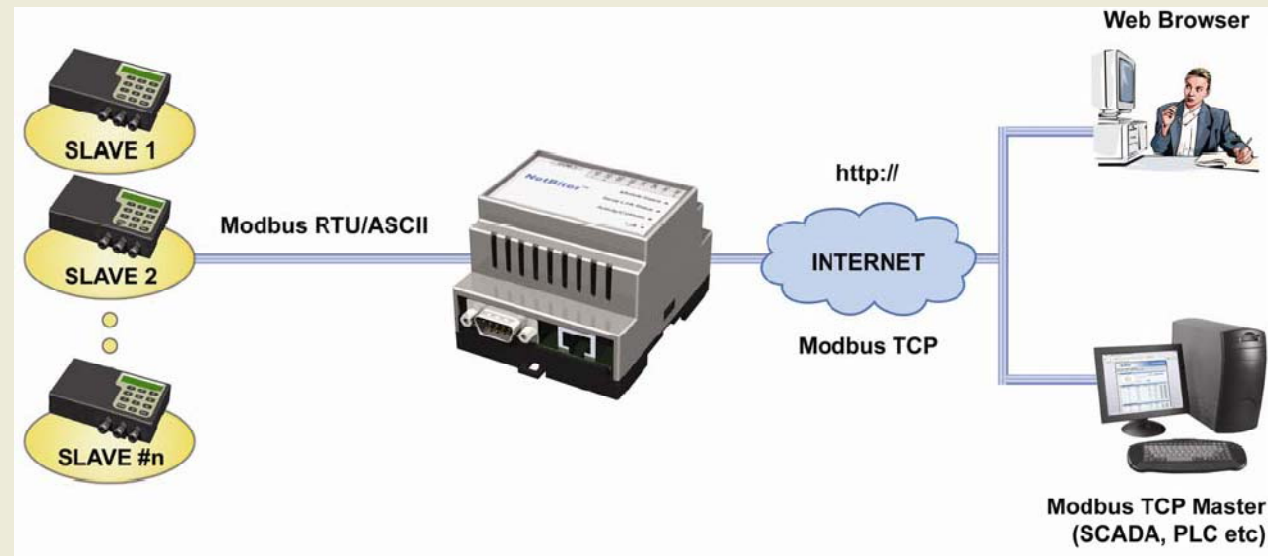

# Communicatie = extra kabels?

Nee:

- Draadloos
  - Zigbee
  - Bluetooth
  - WLAN
- Powerline

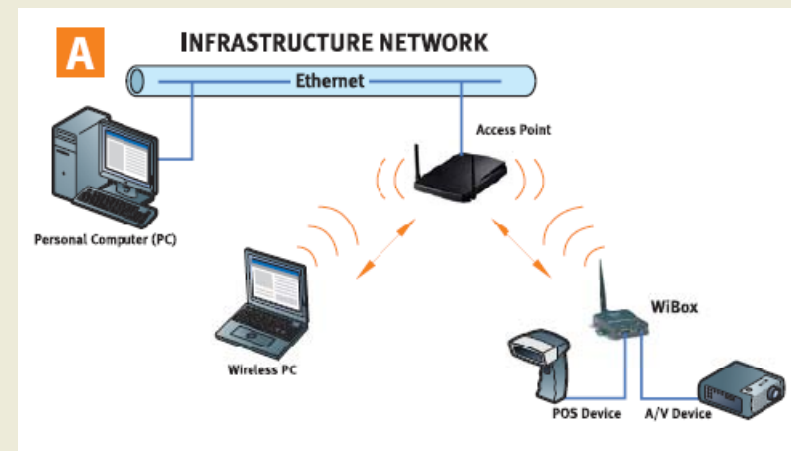
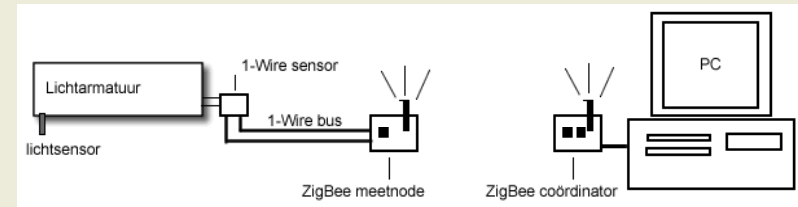

# Communicatie = extra kabels?

Toekomst?

- IPv6: 6LoWPAN

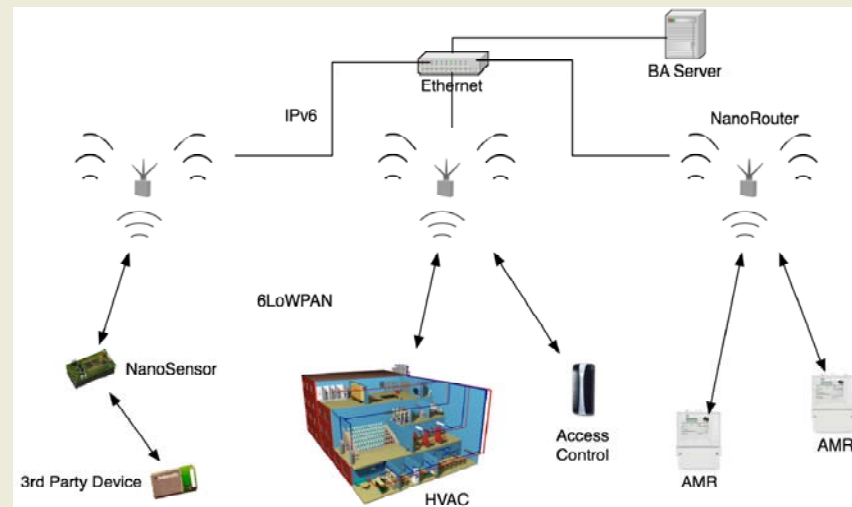

- Energy harvesting – Standby: 0W?
  - EnOcean
  - Greenpeak



# Agenda

1. Inleiding
2. Meten
3. Communicatie
- 4. Data Centralisatie en Visualisatie**
5. Case Studies
6. Besluit

# Energiemonitoring: Technieken voor verlichting

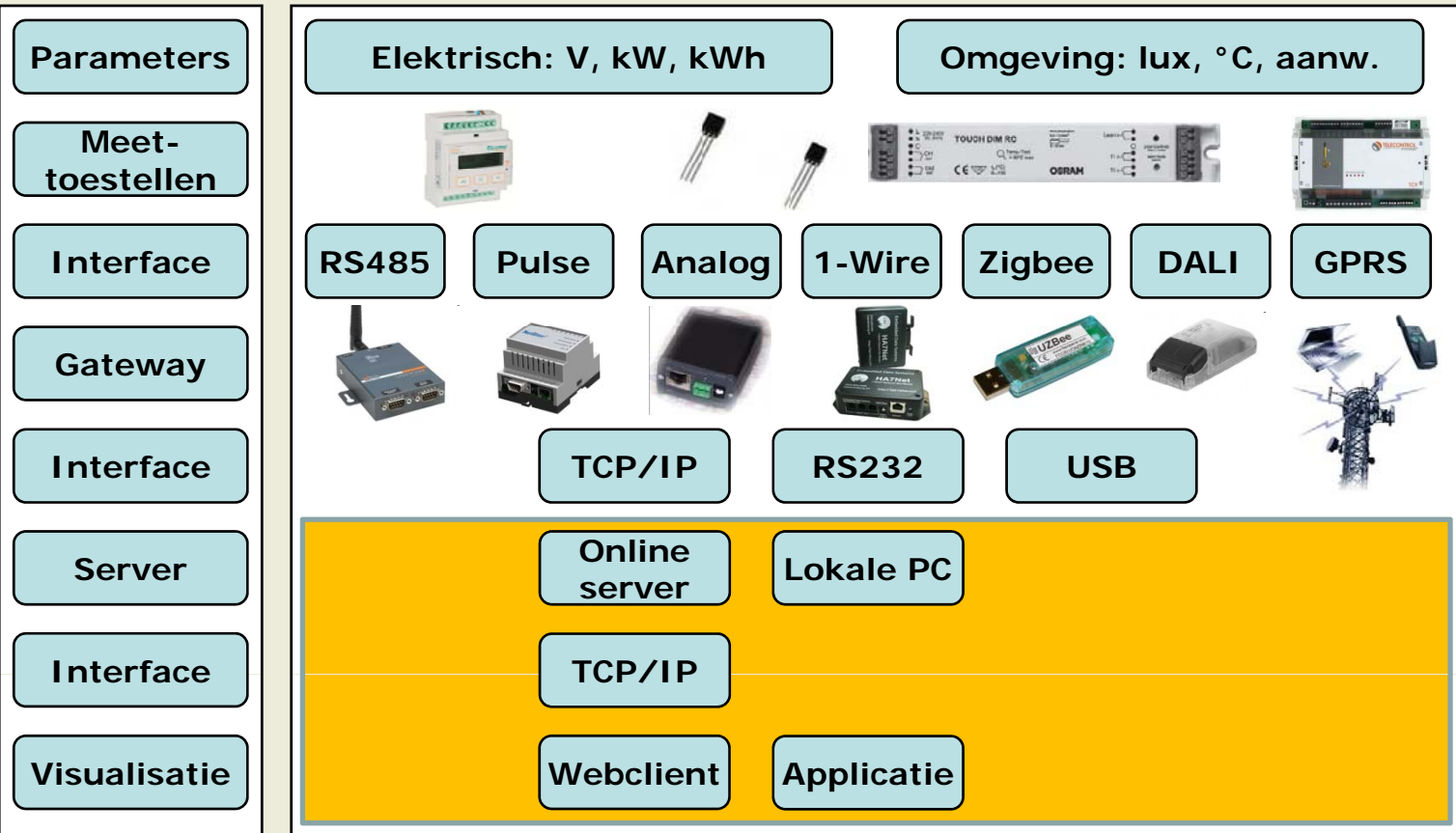



# Centralisatie - Visualisatie

## Intern

- All-in-one:
  - Logger
  - Gateway
  - Webserver
  - Csv export
- PC - software

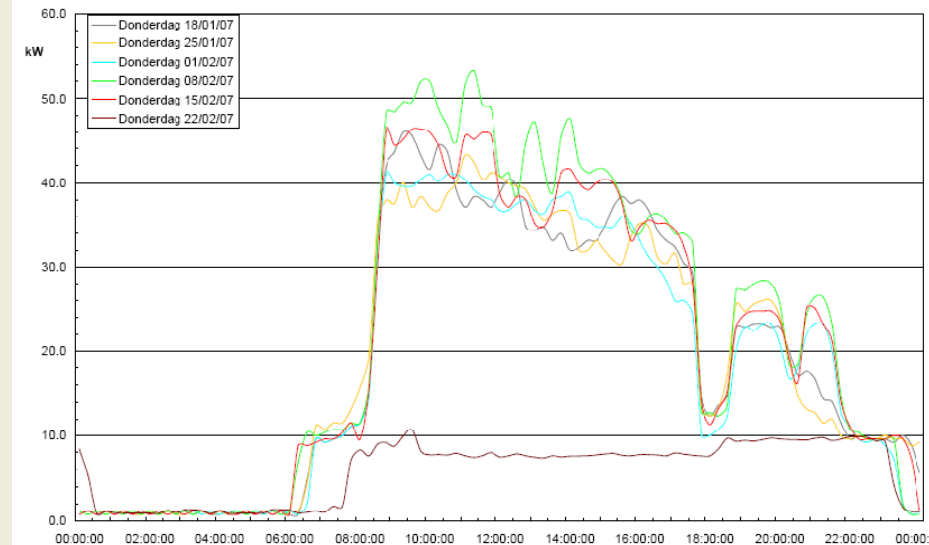
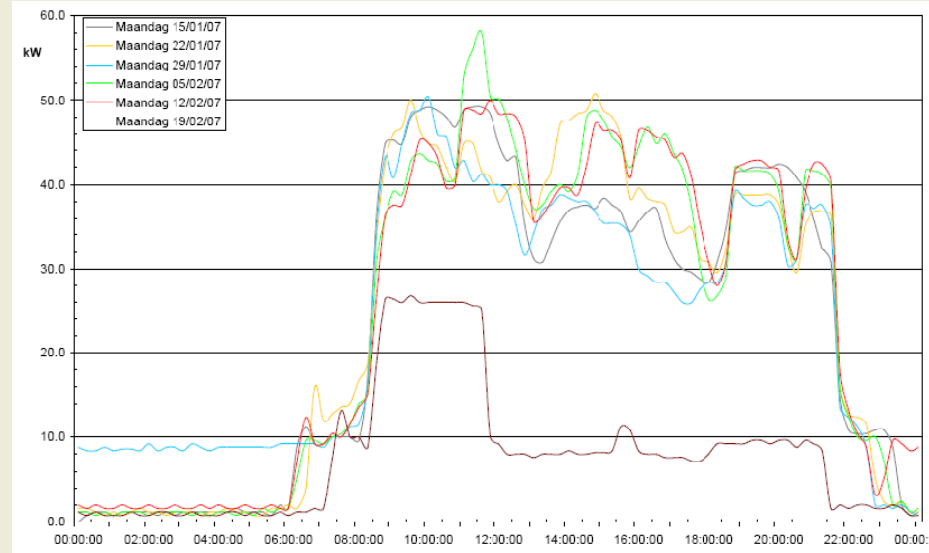
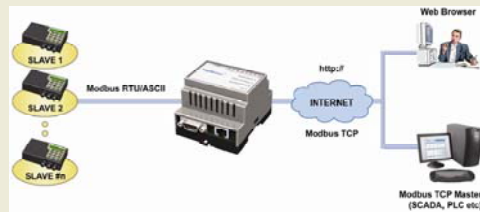

# Centralisatie - Visualisatie

## Extern

- Externe databank
- Toegang via webapplicatie

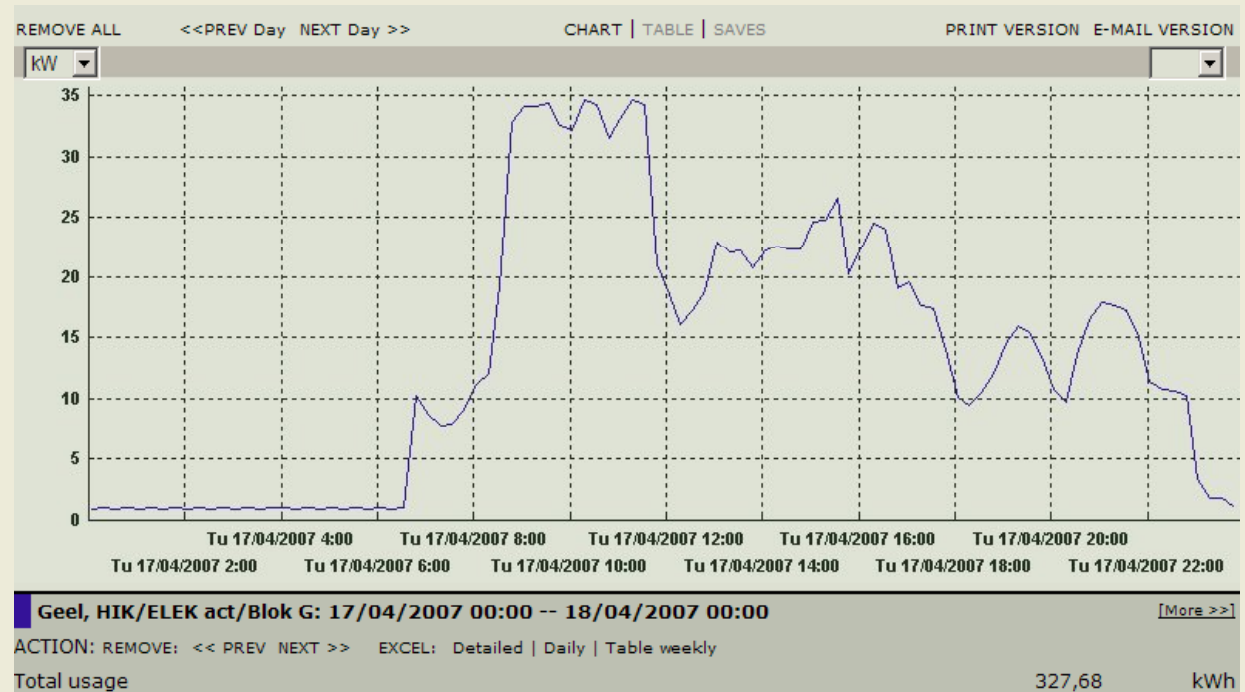
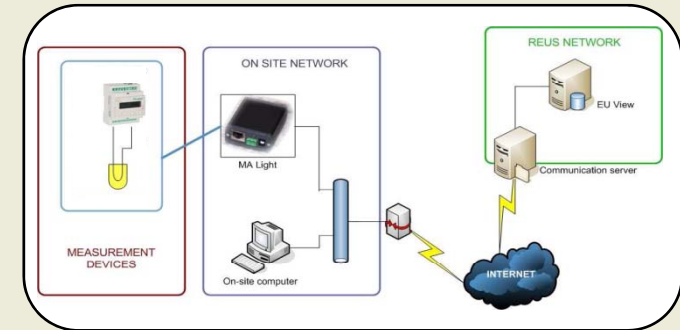



# Agenda

1. Inleiding
2. Meten
3. Communicatie
4. Data Centralisatie en Visualisatie
- 5. Case Studies**
6. Besluit

[www.khk.be](http://www.khk.be)

# Case Study 1

- G-BLOK



# Meetopstelling

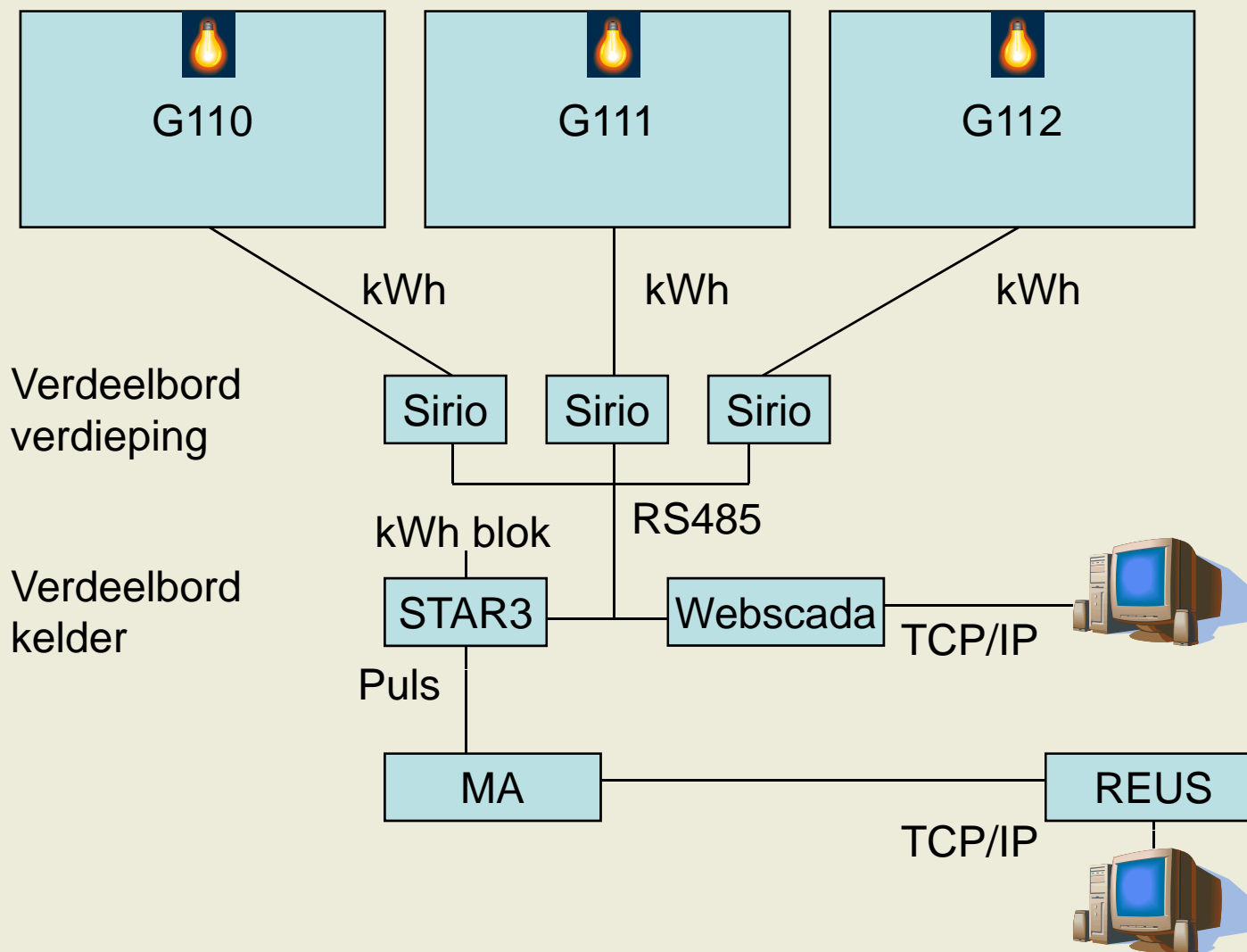

# Netbiter Configuration

www.khk.be



A screenshot of the NetBiter.net web interface displayed in a Windows Internet Explorer browser. The browser's address bar shows the URL: http://www.netbiter.net/www/device\_map.cfm?DID=4798&amp;MENU=manage\_view&amp;SUB=device\_map. The page header includes the NetBiter.net logo and user information: "Logged in: Bart Eestermans, Account: remote, Date: 2008-06-04". There are buttons for "FEEDBACK" and "LOGOUT". The main content area is titled "Device Location: REMOTE01" and features a satellite map with a red location pin. The map includes navigation controls and a legend with options for "Kaart", "Satelliet", and "Beide". A sidebar on the left contains an "ADMIN MENU" with sections for "Projects", "Reports", "Users", "Account Settings", and "Service Messages". The "Projects" section lists various actions like "Projects Overview", "View Project", "View Device", "Alarms &amp; Events", "Historical Data", "Device Notes", "Edit Device", "Project Notes", "View Map", "Edit Project", "Add Device", "File Area", and "Create New Project". The footer of the page shows "©2007 NetBiter.net" and "based on NetBiter® technology". The browser's status bar at the bottom indicates "Gereed" and "Internet" with a 100% zoom level.

www.khk.be



# Weekverbruik G-Blok

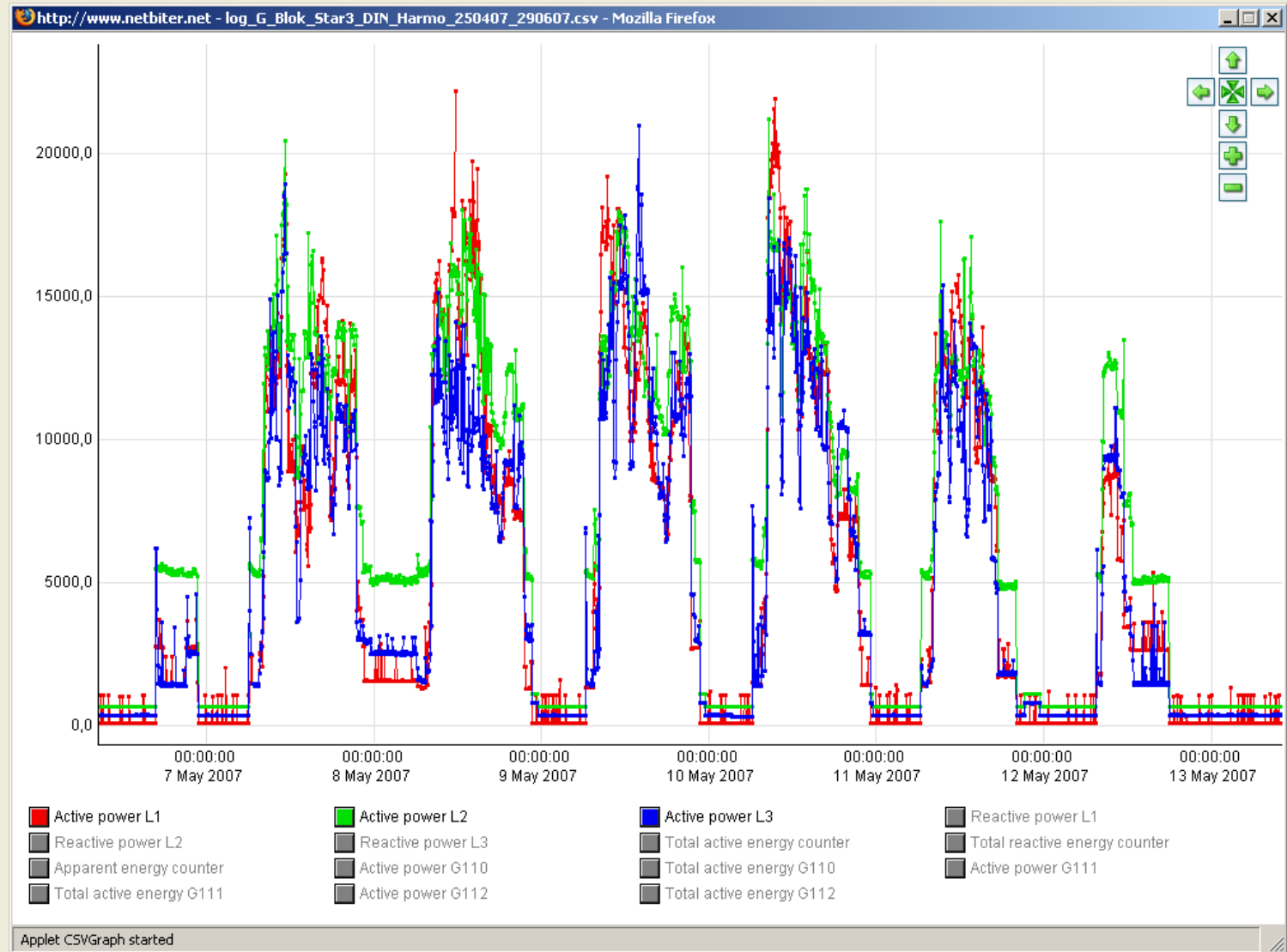

[www.khk.be](http://www.khk.be)

# Verbruiken G-Blok



Bekijken Log files  
(.csv → .xls)



REMOTE

[www.khk.be](http://www.khk.be)

# Case Study 2

- Leslokalen



# Meetopstelling

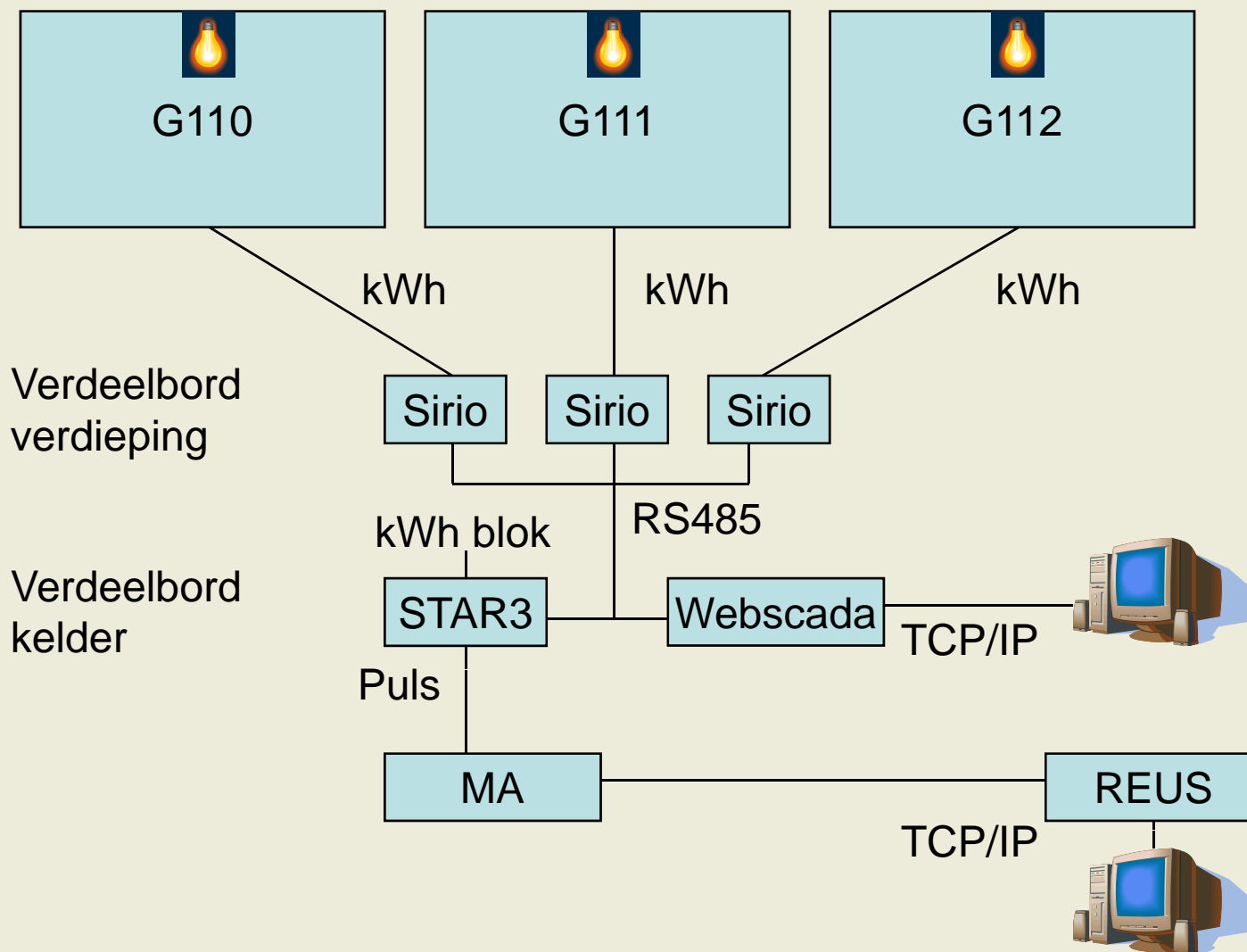

# Meetopstelling

- Energy Meter + RS485 + Netbiter

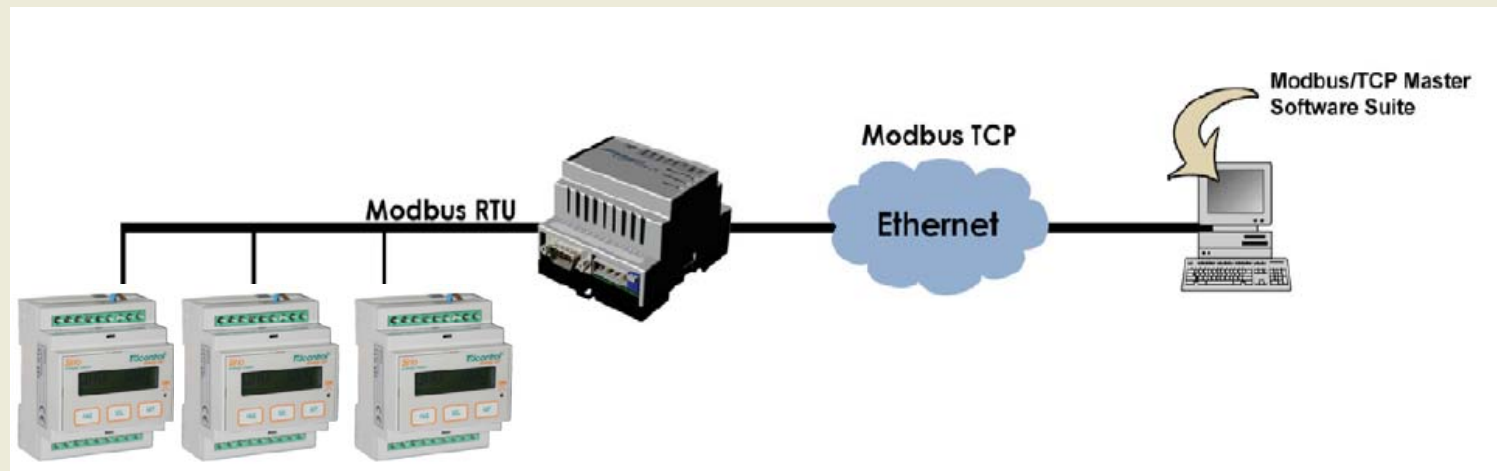

[www.khk.be](http://www.khk.be)



ASSOCIATIE  
K.U. LEUVEN

# Leslokalen

Lux metingen

Indeling lokalen

Bekijken Log files  
([www.netbiter.net](http://www.netbiter.net))

REMOTE

# Dagverbruik Leslokaal

## Case Study: Relighting Leslokalen G-Blok

- Geïnstalleerd vermogen
  - voor relighting: 1210 W
  - na relighting: 660 W
- Vermogen met daglichtdimming
  - minimum 177 W

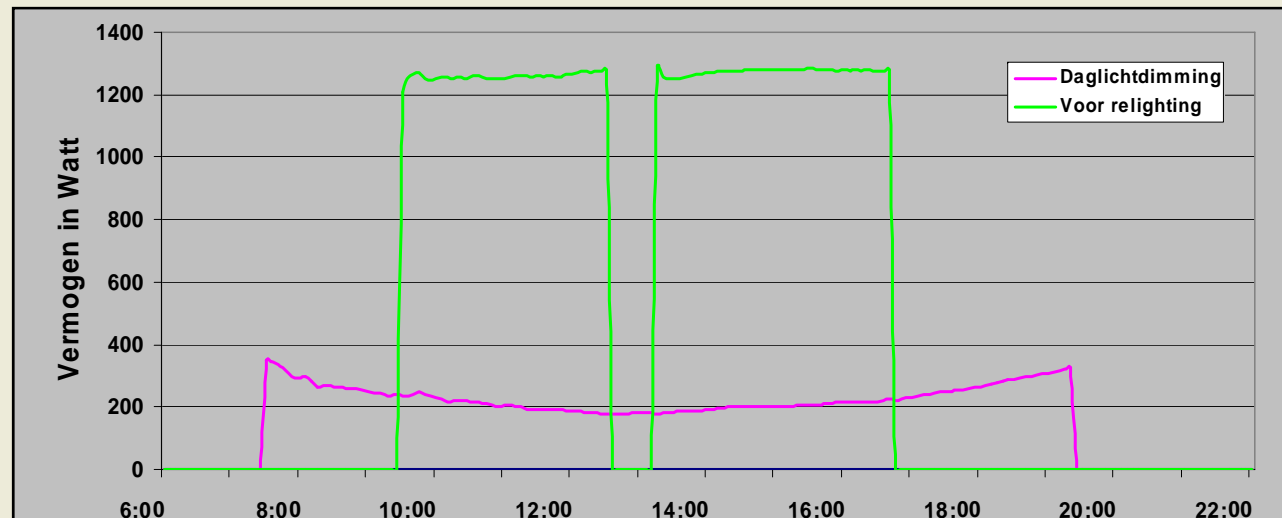

# Uitlezing via DALI

- Ballast + DALI + DALI/Serial + Serial/Ethernet + Local PC Gateway

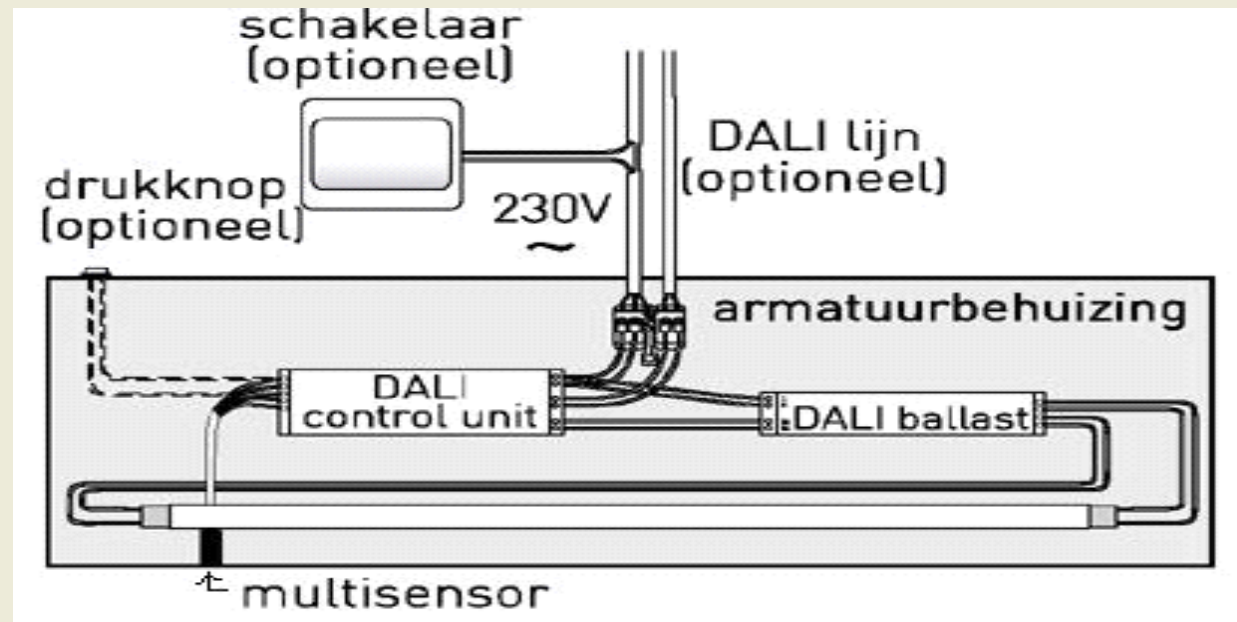

# Case Study 3

- Loggen van temperatuur en verbruik
  - Diepvriezer



# Opstelling

- Sensor + 1Wire + Measurement Agent

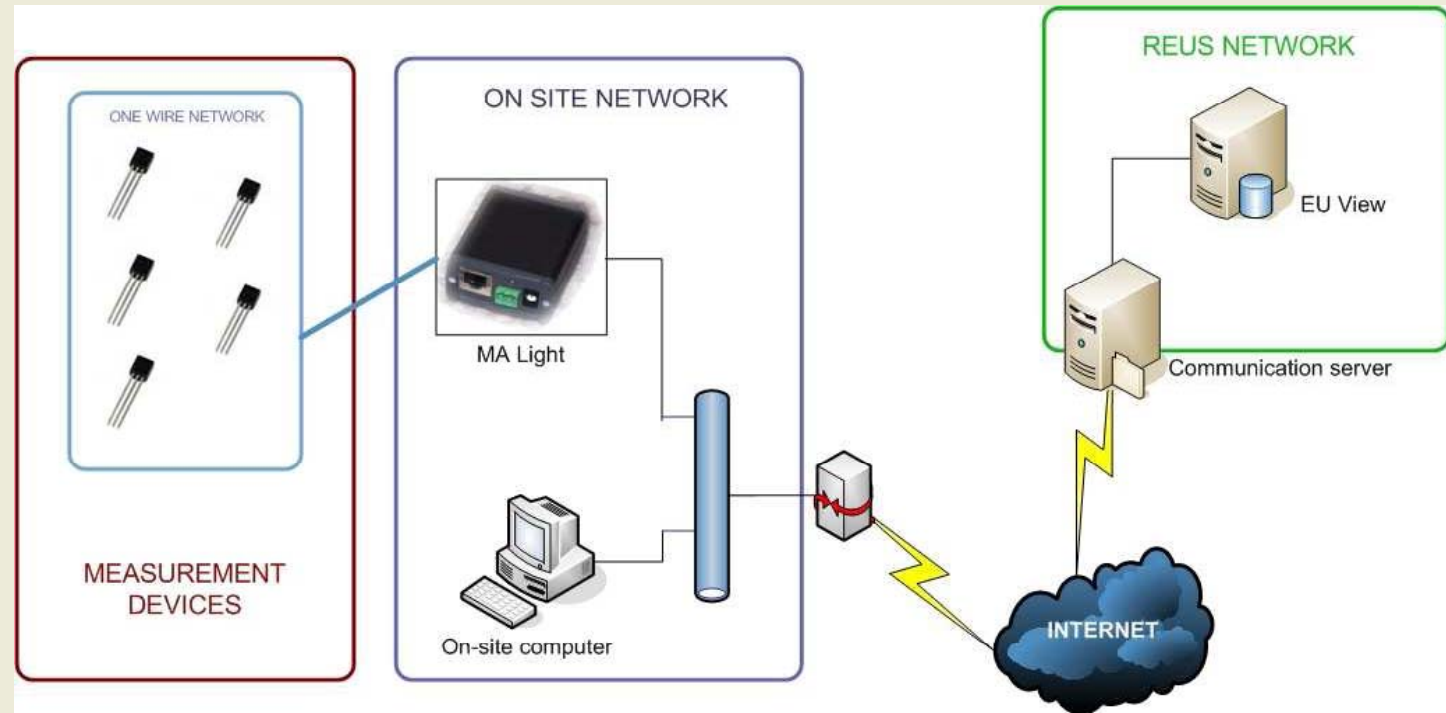

# Opstelling

- Energy Meter + Pulse + Measurement Agent

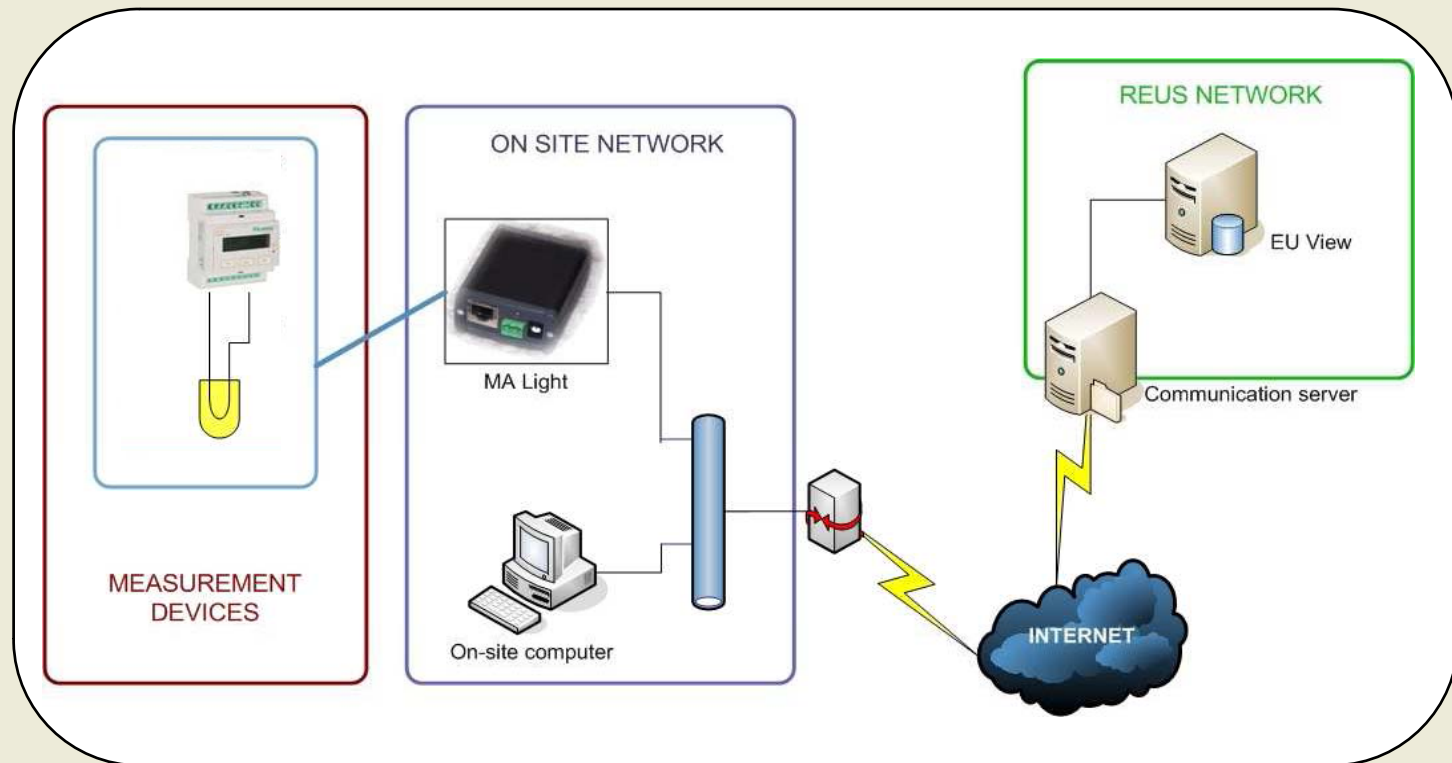

[www.khk.be](http://www.khk.be)



ASSOCIATIE K.U. LEUVEN

The logo of the K.U. Leuven Association is a circular emblem with the text 'ASSOCIATIE K.U. LEUVEN' written around the perimeter. The emblem is partially obscured by a dark blue geometric shape in the bottom-left corner of the slide.

# Resultaat

- Log files  
([www.reus.be](http://www.reus.be))



# Agenda

1. Inleiding
2. Meten
3. Communicatie
4. Data Centralisatie en Visualisatie
5. Case Studies
6. **Besluit**



# Besluit

- Meten meer dan een moment opname < - > opvolging
- Meten meer dan enkel verlichting
- Communicatie < - > extra kabels
- Meten < - > sturen

# Energiemonitoring: Technieken voor verlichting

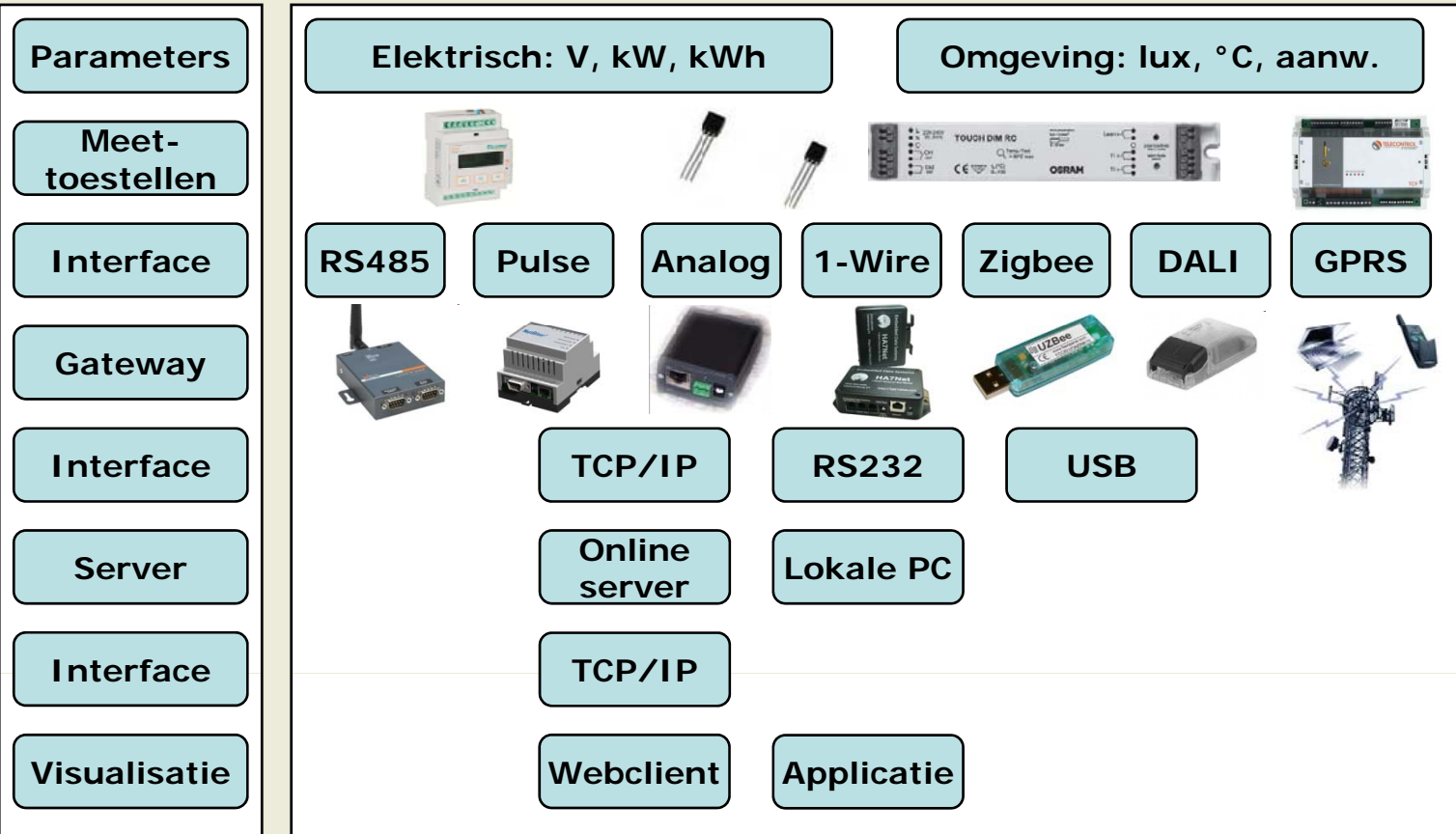

[www.khk.be](http://www.khk.be)



# Remote MOnitoring & control Techniques for Energy management

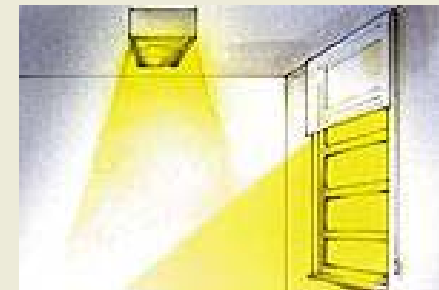
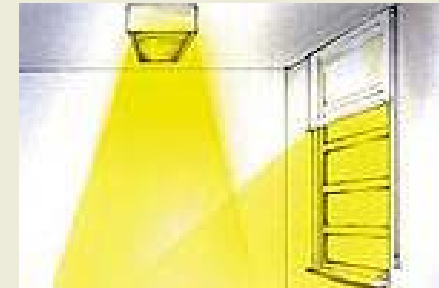

REMOTE